

OPERATION MANUAL

INFRARED THERMOMETER

Features:

- I Precise non-contact measurements
- I Built-in laser pointer
- I Automatic selection range and Resolution to 0.1° or 1°
- I °C/°F switchable button
- I Automatic Data Hold & Auto power off
- I The meter at 12 inches away measure 1 inch target
- I Backlit LCD display

Wide range application:

Food preparation, Safety and Fire inspectors, Plastic molding, Asphalt, Marine and screen printing, measure ink and dryer temperature, Diesel and Fleet maintenance.

Field of View

The meter's field of view is 12:1, meaning that if the meter is 12 inches from the target, the diameter of the object under test must be at least 1 inch. Other distances are shown below in the field of view diagram. Refer to the chart printed on the meter for more information.

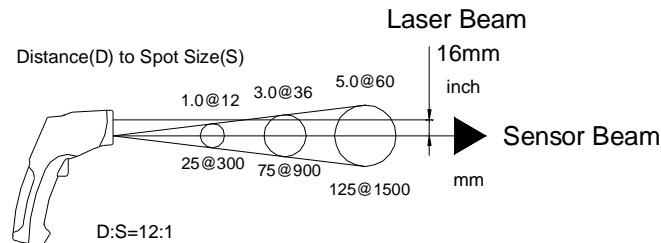
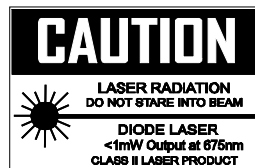

Fig: 1

1. SAFETY

- I Use extreme caution when the laser beam is turned on.
- I Do not let the beam enter your eye, another person's eye or the eye of an animal.
- I Be careful no to let the beam on a reflective surface strike your eye.
- I Do not allow the laser light beam impinge on any gas which can explode.



2. SPECIFICATIONS

I General specifications

DISPLAY	3-1/2 digit (1999count) LCD with backlighting
MEAS.RANGES/RESOLUTION	-50.0°C to 750°C/-58.0°F to 1382°F (0.1° up to 200°, 1° over 200°)
RESPONSE TIME	Less than 1 second
OVER RANGE INDICATION	LCD will show "1"
POLARITY	Automatic (no indication for positive polarity); Minus (-) sign for negative polarity.
EMISSIVITY	0.95 fixed value
FIELD OF VIEW	D/S = Approx. 12:1 ratio (D = distance, S = spot) (Has 90% encircled energy at the focal point)
DIODE LASER	Output <1mW, Wavelength 630~670nm, class 2 (II) Laser product
SPECTRAL RESPONSE	8~14um
POWER OFF	Automatic shut off after 7 seconds, approx.
OPERATING TEMP.	0°C to 50°C (32°F to 122°F)
STORAGE TEMP.	-20°C to 60°C (-4°F to 140°F)
RELATIVE HUMIDITY	10%~90%RH operating, <80%RH storage
POWER SUPPLY	9V battery, NEDA 1604A or IEC 6LR61, or equivalent
WEIGHT	290g.
SIZE	100 x 56 x 230mm

I Infrared thermometer specifications

Range (Automatic selection 0.1 °C/ 1°C)		Resolution	Accuracy
-50.0°C to 200.0°C	-50.0°C to -20.0°C	0.1 °C	± 5 °C;
	-20.0°C to 200.0°C		± 1.5% of reading ± 2°C;
201 °C to 538 °C		1 °C	± 2% of reading ± 2°C ;
539 °C to 750 °C			± 3.5% of reading ± 5°C .

Range (Automatic selection 0.1 °F/ 1°F)		Resolution	Accuracy
-58.0°F to 200.0 °F	-58.0 °F to -4.0 °F	0.1°F	± 9°F;
	-4.0 °F to 200.0 °F		± 1.5% of reading ± 4°F;
201°F to 1000°F		1 °F	± 2% of reading ± 4°F;
1001°F to 1382°F			± 3.5% of reading ± 9°F .

Note:

Accuracy is given at 18 °C to 28 °C (64 °F to 82 °F), less than 80 % RH.

Field of View:

Make sure that the target is larger than the unit's spot size. The smaller the target, the closer you should be to it. When accuracy is critical, make sure the target is at least twice as large as the spot size.

Emissivity: 0.95 fixed value

3. FRONT PANEL DESCRIPTION

- ① IR sensor
- ② Laser pointer beam
- ③ LCD Display
- ④ °F select key
- ⑤ °C select key
- ⑥ Backlight select key
- ⑦ Laser select key
- ⑧ Measurement Trigger
- ⑨ Handle Grip
- ⑩ Battery Cover

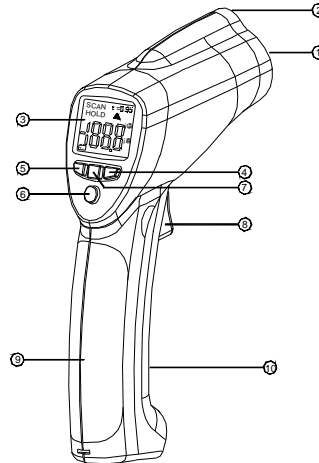

4. INDICATOR

- ① Digital readout
- ② Temperature °C (Celsius)
- ③ Temperature °F (Fahrenheit)
- ④ Measuring indication
- ⑤ Data Hold
- ⑥ LOW battery indicator
- ⑦ Laser Point
- ⑧ Fixed emissivity (0.95)

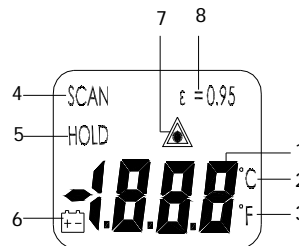

5. MEASUREMENT OPERATION

- ① Hold the meter by its **Handle Grip** and point it toward the surface to be measured.
- ② Pull and hold the **Trigger** to turn the meter on and begin testing. The display will light if the battery is good. Replace the battery if the display does not light.
- ③ While measuring, the SCAN display icon will appear in the upper left hand corner of the LCD.
- ④ While continuing to pull the Trigger:
 - a. Push the **Laser** button to turn on the laser pointer. When the laser is on the laser icon  will appear on the LCD over the temperature. Aim the red beam approximately a half inch above the point of test (pressing the Laser button again turns the laser off).
 - b. Select the temperature units (°C or °F) using the **°C** and **°F** buttons.
 - c. Push the **Backlight** key to turn on the LCD backlighting function.
- ⑤ Release the Trigger and the HOLD display icon will appear on the LCD indicating that the reading is being held.
- ⑥ The meter will automatically power down after approximately 7 seconds after the trigger is released.

Note: Measurement considerations

Holding the meter by its handle, point the IR Sensor toward the object whose temperature is

to be measured. The meter automatically compensates for temperature deviations from ambient temperature. Keep in mind that it will take up to 30 minutes to adjust to wide ambient temperatures are to be measured followed by high temperature measurements, some time (several minutes) is required after the low (and before the high) temperature measurements are made.

This is a result of the cooling process which must take place for the IR sensor.

6. BATTERY REPLACEMENT

- ① As battery power is not sufficient, LCD will display “” replacement with one new battery type 9V is required.
- ② Open battery cover, then take out the battery from instrument and replace with a new 9-Volt battery and place the battery cover back.

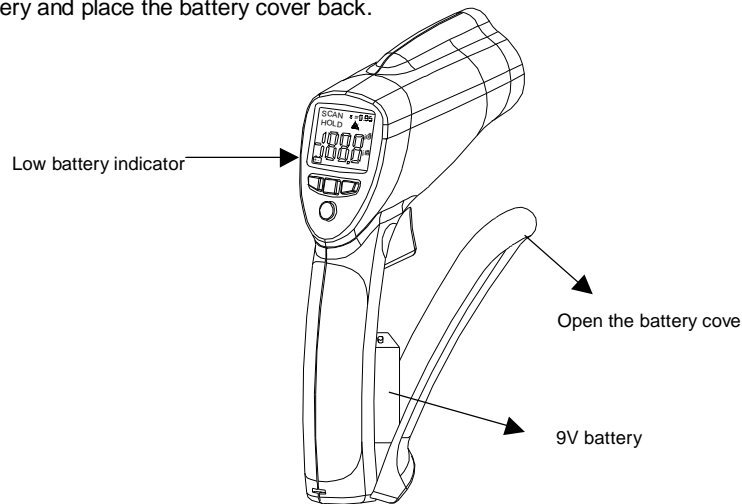

7. NOTES:

I **How it Works**

Infrared thermometers measure the surface temperature of an object. The unit's optics sense emitted, reflected, and transmitted energy, which is collected and focused onto a detector. The unit's electronics translate the information into a temperature reading which is displayed on the unit. In units with a laser, the laser is used for aiming purposes only.

I **Field of View**

Make sure that the target is larger than the unit's spot size. The smaller the target, the closer you should be to it. When accuracy is critical, make sure the target is at least twice as large as the spot size.

I **Distance & Spot Size**

As the distance (D) from the object increases, the spot size (S) of the area measured by the unit becomes larger. See: **Fig: 1**.

I **Locating a hot Spot**

To find a hot spot aim the thermometer outside the area of interest, then scan across with an up and down motion until you locate hot spot.

I **Reminders**

- ① Not recommended for use in measuring shiny or polished metal surfaces (stainless steel, aluminum, etc.). See **Emissivity**
- ② The unit cannot measure through transparent surfaces such as glass. It will measure the

surface temperature of the glass instead.

③ Steam, dust, smoke, etc., can prevent accurate measurement by obstructing the unit's optics.

I Emissivity

Most (90% of typical applications) organic materials and painted or oxidized surfaces have an emissivity of 0.95 (pre-set in the unit). Inaccurate readings will result from measuring shiny or polished metal surfaces. To compensate, cover the surface to be measured with masking tape or flat black paint. Allow time for the tape to reach the same temperature as the material underneath it. Measure the temperature of the tape or painted surface.

Emissivity Values

Substance	Thermal emissivity	Substance	Thermal emissivity
Asphalt	0.90 to 0.98	Cloth (black)	0.98
Concrete	0.94	Human skin	0.98
Cement	0.96	Lather	0.75 to 0.80
Sand	0.90	Charcoal (powder)	0.96
Earth	0.92 to 0.96	Lacquer	0.80 to 0.95
Water	0.92 to 0.96	Lacquer (matt)	0.97
Ice	0.96 to 0.98	Rubber (black)	0.94
Snow	0.83	Plastic	0.85 to 0.95
Glass	0.90 to 0.95	Timber	0.90
Ceramic	0.90 to 0.94	Paper	0.70 to 0.94
Marble	0.94	Chromium oxides	0.81
Plaster	0.80 to 0.90	Copper oxides	0.78
Mortar	0.89 to 0.91	Iron oxides	0.78 to 0.82
Brick	0.93 to 0.96	Textiles	0.90